

Bar Light

FLDL-Si150X27

Lighting Picture



Lighting Dimension

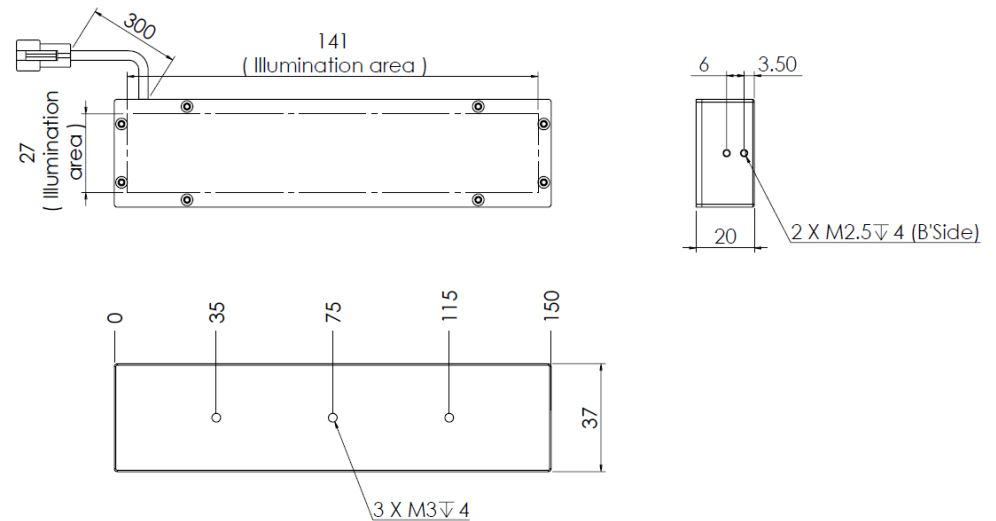

Mechanical Information	
Casing Material	Aluminium
Storage Temperature Range	Temp 0-35°C, Humidity 20-85%
Weight	161g
Lighting Dimension WxLxH	37.0 x 150.0 x 20.0 mm
IP Rating	N/A

Unit in mm



Optical Information	
Led Color	RED (R24)
Wavelength	626nm
Illumination (number of LED)	110
Illumination Area	141 X 27mm
Led Package	SMD
Eye Safety (EN 62471:2008)	Exempt Group

Electrical Information	
	R24
Lighting Supply Voltage (constant voltage mode)	24V ± 2%
Supply Ripple Voltage	≤ Vs ± 5%
Reverse Battery Protection	YES
Lighting Forward voltage, (for zero internal resistor value)	22.0 V
Continuous Current	0.44A (MAX)
Power Consumption	10.56 W
Lighting casing temperature, Operating after 60 minutes	57°C

Strobe Mode Specification	
	R24
Max. Lighting Supply Voltage (Constant voltage power supply)	Pulsing at 24VDC to 48VDC, 0-10% Duty Cycle Recommended at 36VDC
Pulse Current, (Max. 10msec) (Constant current power supply)	1.10A (MAX)
Max. Trigger Pulse Duration, msec	10 msec
Duty Cycle	0 - 10%

Ordering Option	
FLDL-Si150X27-R24	With resistor to limit the current (Use in both constant voltage/ current power supply)
FLDL-Si150X27-R24-0	Internal resistor value= zero ohms (only use in constant current power supply)



Connection		R24		
Connector Type (Default):	JST SMR-03V			
	Pin	Signal	Cable Color	
	1	LED +	Black/White	
	2	N.C.	---	
	3	LED -	Black	
Cable Length out from lighting:	300 mm			

Additional Information		R24		
Additional Cooling Method	Attached to machine part for better heat dissipation			
Life span in continuous mode,	20,000 hours			
Life span in strobe light mode Lighting drop to 50% intensity (at 25°C ambient temperature)	50,000 hours			
Intensity Controller Selection	PSA-Series, PSD-Series, LIC-Series			
CE Conformity	YES			
RoHS Compliance	YES			
ISO 9001:2008	SG11/03751			

Application	
Optimal Working Distance	0-100 mm



Disclaimer

IMPORTANT NOTICE:

ALL PRODUCT, PRODUCT DATA SHEET AND DATA ARE SUBJECT TO CHANGE WITHOUT NOTICE TO IMPROVE QUALITY, RELIABILITY, FUNCTION, DESIGN OR OTHERWISE.

Other disclaimers:

- 1) FALCON ILLUMINATION (M) SDN.BHD (termed as FALCON), its affiliates, agents, distributors and employees, and all persons acting on its or their behalf (FALCON collectively), disclaim any and all liability for any errors, inaccuracies or incompleteness contained in any datasheet or in any other disclosure relating to any product.
- 2) FALCON makes no warranty, representation or guarantee regarding the suitability of the products for any particular purpose or the continuing production of any product. To the maximum extent permitted by applicable law, FALCON disclaims:
 - (i) any and all liability arising out of the application or use of any product,
 - (ii) any and all liability, including without limitation special, consequential or incidental damages, and
 - (iii) any and all implied warranties, including warranties of fitness for particular purpose, non-infringement and merchantability.
- 3) Information and statements regarding the suitability of products for certain types of applications are based on FALCON's knowledge of typical requirements that are often placed on our products datasheet for generic applications. Such statements or information are not binding statements about the suitability of products for a particular application. It is the customer's responsibility to verify and/or validate that a particular product with the properties described in our product data sheet is suitable for use in a particular application.
- 4) Parameters provided in product datasheets and/or specifications may vary in different applications and performance may vary over time. All operating parameters, including typical parameters, must be verified and/or validated for each customer application by the customer's technical experts.
- 5) Except as expressly indicated in writing, FALCON I's products are not designed for use in medical, life-saving, or life-sustaining applications or for any other application in which the failure of the product could result in personal injury or death. Customers using or selling our products not expressly indicated for use in such applications do so at their own risk and agree to fully indemnify and hold FALCON and its distributors harmless from and against any and all claims, liabilities, expenses and damages arising or resulting in connection with such use or sale, including attorneys fees, even if such claim alleges that FALCON or its distributor was negligent regarding the design or manufacture of the part. Please contact authorized FALCON personnel to obtain written terms and conditions regarding products designed for such applications.

